

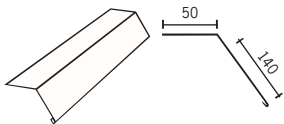

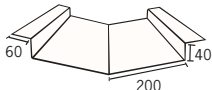

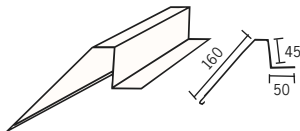

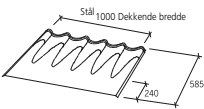

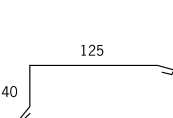
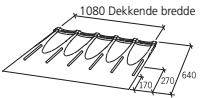
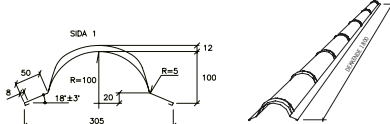

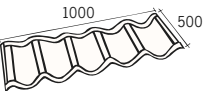
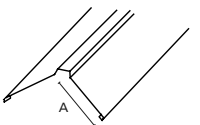
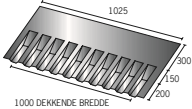
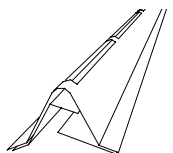
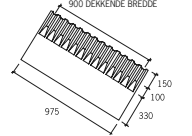
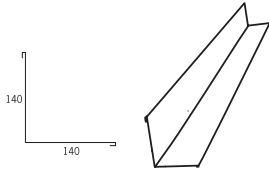
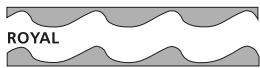
# Blikk, beslag, og tilbehør

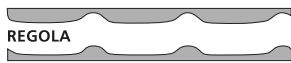
Plannja har et komplett produktprogram av nødvendig tilbehør i forskjellige farger. For en sikker montering, benytt alltid Plannjas originale tilbehørsprogram. For mer informasjon kontakt din forhandler eller [plannja.no](http://plannja.no)

Artikkel	Art.nr	Artikkel	Art.nr		
Takfotbeslag		326602	Vinkelrenne Dekkende L = 1750		326802
Takfotbeslag Regola L= 2000 mm		327436	Overgangspanne Royal, stål		327226
Gavlbeslag L= 2000 mm		326624	Rapid		327020
Mønepanne. Dekkende L= 1800 mm		327217	Regola		327421
Endelukk til Mønepanne		327212	Tilpassingsplate Royal/Regent 1 sten		
Mønebeslag L=2000 mm Stål/Aluminium  A=165 mm		326633	Overgangsbeslag Plannja 20 Stål		327014
Ventilert møne, tre deler Hull 50x290 c/c 330  Mål 122+Takhelling Bøyes til rett vinkel på plass		326642V	Overgangsbeslag Plannja 20-75 Aluminium		327016
Tak/Veggbeslag Innv.hjørne Utv.hjørne  L= 2000 mm		326211 326201	Tetningsbånd over under ROYAL		
			over under REGENT		
			over under RAPID		
			over under REGOLA		
			side		
			Plannja 20, Plannja 20-100 Plannja 20-75 Selvklebende tetningsbånd, 10x3 mm	342601 342665 342630	

Selvborende skruer	Art.nr
4,8x35 mm, tak/fasade, galv. lakkert 	312004
4,8x20 mm, overlapp, galv. lakkert 	312005
4,8x35 mm, tak/fasade, rustfri, lakkert 	312045
4,8x20 mm, overlapp, rustfri, lakkert 	312046
5,5x35 mm, tak/fasade, alu., lakkert 	312420
5,5x20 mm, overlapp, alu., lakkert	312422
6,5x50 mm, lekt/Regola, galv.	312208
6,0x140 mm, innfest, trelekt, galv.	312200
<b>Diverse</b>	
Hylse 8 mm klemring	311030
Reparasjonslakk 1/3 I, Matt Polyester Metall-lakk/Plastisol	362706 362704
Lektepapp, mellom alu. og tre, 83 mm	342690
Lyse plater Plannja 20 Plannja 20-75 Plannja 30	34 Plast 20 34 Plast 20-75 34 plast 30
Sprøytepipstol til tettefett	24 2699
Plane Plater Stål Metall-lakk Plastisol SCE 180 um Plastisol SCE 500 um	<b>Format</b> 2000x1200x0,6 2000x1250x0,6 2000x1200x0,55
Aluminium Metall-lakk	2000x1200x0,9

## Avstand bærelekt

Velg bærelektavstand i henhold til tabellen under. Alle mål i mm. Mål A og B – se skissen.

	Bærelekt 30x48	Bærelekt 36x48
<b>Royal A</b>	375	375
<b>B</b>	400	400
<b>Regent A</b>	325	325
<b>B</b>	350	350
<b>Rapid A</b>	435	435
<b>B</b>	460	460

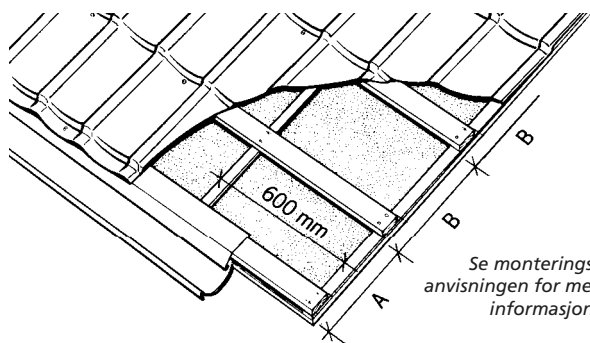

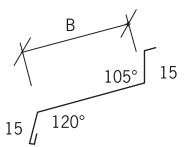
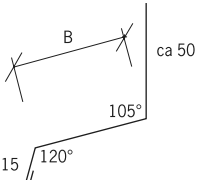
Vindusbeslag	Art.nr
<b>Underbeslag</b> B = 40 B = 60 B = 80 B = 100 B = 130 B = 150 B = 190	326540 326560 326580 326510 326513 326515 326519
	
<b>Overbeslag</b> B = 40 B = 60 B = 80 B = 100 B = 130 B = 150 B = 190	326340 326360 326380 326310 326313 326315 326319
	

Vindusbeslag i bredde 130, 150, 190 er i 2000 mm lengde.  
 De øvrige leveres også i lengder 1200/stål og 1500 mm/stål, aluminium.

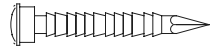
Festemidler	Art.nr
Skruer for vindusbeslag, 3,5x25mm, 100 stk/pk. Rustfri. Bits medfølger. 	312320
Blikkspiker, 2,5x30 mm, 100 stk/pk. 	312503

### Fargeprogram – Beslag



01 Svart



06 Sølvmetallic



13 Mosegrønn



20 Mørkegrå

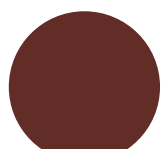

22 Mørkerød



26 Mørkebrun

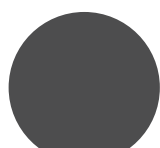

30 Antrasittgrå

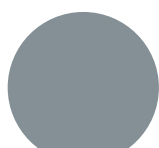

35 Sinkgrå

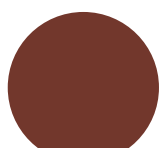

42 Brunrød

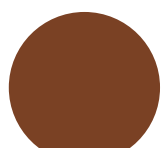

48 Rød

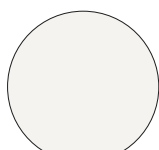

50 Hvit

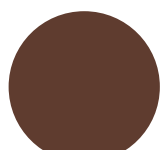

52 Rødbrun

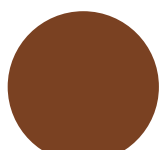

78 Teglrød



80 Klar hvit

Av trykktekniske årsaker kan fargene ikke gjengis korrekt.